

Experimental Study Effect of the Flexible Collar on Bridge Pier Scouring Depth

A. Safaei¹, M. Solimani Babarsad^{2*}, R. Aghamajidi³ and P. Eftekhari⁴

1- Water Science and Environmental Research Center, Shoushtar Branch, Islamic Azad University, Shoushtar, Iran.

2* - Corresponding Author, Department of Water Sciences, Water Science and Environmental Research Center, Shoushtar Branch, Islamic Azad University, Shoushtar, Iran. (Mohsen.solb@gmail.com).

3- Assistant Professor Civil Department, Islamic Azad University, Sepidan Branch, Sepidan, Iran.

4- Department of Water Engineering, Faculty of Civil and Environment Engineering, University of Amir Kabir (Poly Technic), Tehran, Iran.

ARTICLE INFO

Article history:

Received: 11 July 2021

Revised: 27 September 2021

Accepted: 28 September 2021

TO CITE THIS ARTICLE :

Safaei, A., Solimani babarsad, M., Aghamajidi, R., Eftekhari, P. (2021). 'Experimental Study Effect of the Flexible Collar on Bridge Pier Scouring Depth', Irrigation Sciences and Engineering, 44(2), pp. 53-66. doi: 10.22055/jise.2021.37936.1982.

Keywords:

Bridge Pier, Flexible Collar,
Scour Depth, Local Scouring,
Horseshoe Vortex.

Abstract

Bridge pier's local scouring is known to be a destructive factor in river engineering science. This phenomenon is widespread in river intersecting structures such as bridge piers, spur dykes, and downstream river structures. Extensive research has been conducted to reduce and control destructive phenomena, and many solutions have been proposed. These solutions are divided into two parts, namely, direct and indirect protection. In this study, the direct method was studied by defining scenarios. Since many bridges are affected by scouring during the operation, in the present study, the collar method, which is known as a direct protection method, in the case of flexible and permeable, is suggested. The technique is presented an adjustable chain collar, three times bigger than the pier's width ($w/d=3$), and its effect is investigated in clear water conditions. In the defined scenarios, three different diameters of the chain as CI=5 mm, CII=10 mm, and CIII=15 mm were used to control chain shapes' effect, and three dimensionless flow parameters ($U/U_c=0.73, 0.85, \text{ and } 0.96$) were selected to investigate the effect of flow conditions. According to the results, the scour depth is related to changes in the diameter of the collar chain, as the final scour depth decreases by increasing the diameter of the chain from CI to CIII. Therefore, in the best conditions, for CIII, the dimensionless ratio of scouring reduction ($\frac{d_s}{d_{smax}}$) is equal to 71% near to inception motion parameter ($U/U_c=0.96$).

Introduction

Scouring is a phenomenon that occurs due to the interaction of flow conditions and the movement of bed materials along rivers and waterways due to the passage of flow. The depth of bed erosion compared to the original bed is called the scour depth (Shafai Bajestan et al., 2018). Due to the collision of water flow with the bridge pier and the creation of separation phenomenon, which complicates the flow field and creates a vortex around the

bridge pier, local scouring occurs in the bed around the bridge pier. Scouring is considered one of the leading causes of destruction and damage to bridges. Numerous researchers have conducted many studies on this phenomenon over the past years that their results have been effective in preventing bridge damage. The various flow structures around the bridge pier include downflow and the horseshoe vortex at the front of the pier and the vortices, resulting

from the separation of the flow from the bridge pier at the sides and downstream of the pier. Experimental results have shown that due to the presence of vortices, the bed materials around the bridge piers are exposed to the forces of the flow and the resulting vortices (Karimaei Tabarestani, 2020). In a rectangular pier, the direction of flow due to the expansion of the separation area, on the side and behind of the pier, the strength of the vortices increases around the base, which directly impacts the scour depth (Solimani Babarsad and Safaei, 2021). The phenomenon of local scouring around the bridge pier is very complicated because of the rotations and vortices that occur around the pier, which is shown in Fig.(1). Since many parameters effectively inform this phenomenon, the study of this phenomenon is currently done in the laboratory using small-scale models.

Many researchers (Solimani Babarsad et al., 2021), (Wang et al., 2020), (Adib et al., 2019), (Karimaei Tabarestani, 2020), (Gohari and Rezaei, 2020), (Karimi et al., 2017), (Khozaymehnezhad and Ghomeshi, 2016), (Safaei et al., 2015) have studied local scouring around bridge piers in the laboratory using numerical modeling and investigated various aspects of the parameters affecting the scour depth. In addition, their results have led to the interpretation of the flow field and the scour pattern around the bridge piers, which resulted in the division of scour depth reduction scenarios into two main parts. In general, various scour control methods are done in two forms: Erosion control and impact reduction of erosive forces (Akhlaghi et al., 2020). In the first method, the resistance of the bed is increased against the incoming tensions by protecting and strengthening the bed, such as different kinds of ripraps or blankets. On the other method, it is stabilized by protective piles, submerged plates, sills and creating gaps by changing the flow pattern around the pier to reduce erosive parameters such as secondary currents and horseshoe vortices (Solimani Babarsad et al., 2021). Using collars for the scour depth reduction is classified in the direct method. In recent years, many studies have been done on the collar's performance.

Mechanism of Influence of Collars on Scour Depth around the Bridge Pier

A study has investigated the effect of netted collar position on the scour depth around an oblong-shape bridge pier (Taheri and ghomeshi, 2018). They used simple and netted collars with 30, 50, and 70% openings in four positions, including at the bed level, $0.12B$ below the bed, and $0.5B$ and B above the bed. It has shown that the bed level and below the bed are the best positions for installing collars. The bed level has shown 100% efficiency in the simple collar and 92% in the netted collar of 70% in reducing the scour depth. Also, the performance of all collars below the bed was the same and reduced scouring depth by 88%. In addition, the other study has investigated the performance of netted collar on the scour depth reduction at bridge rectangular abutment in the composite channel (Alem et al., 2013). In their study, three netted collars were tested with 20, 33, and 50% openings and twice the width of the bridge abutment. They were placed in three positions on the bed, 2 and 4 cm above the bed and as a result, netted collar of 30% have had the best performance. On the one hand, research has shown the effect of placing simple and netted collars on scouring around the cubic pier of the bridge with a width of 40 mm in clear water conditions by four positions such as simple collar and netted collars of 15, 30, and 40% by considering three different numbers of Froude 0.19, 0.16, and 0.13 (Jalili and Ghomeshi, 2016). After this, the performance of the collars at $0.5B$ and $0.25B$ above the sedimentary bed level was compared with the initial results without the collar. It has been demonstrated that there is a 34 to 97% reduction in the maximum depth of scouring in terms of netted collars. Additionally, the scouring rate has decreased by reducing the Froude number in all collars with different opening percentages. The other research investigated the effectiveness of a semicircular collar on reducing the scour depth around the abutment to determine changes in the flow pattern around it (Shahsavari et al., 2020). Indeed, it was examined in clear water conditions and semicircular collars on semicircular abutment in two sizes $1.5L$ and $2L$, and at three different levels, such as bed level and

0.2L below and above it. The results showed that using the collar reduced the final scour depth and delayed the scouring process, which is observed by increasing the size of the collar. Moreover, the alignment of collars with equal size can cause their better performance and, finally, reduce the design cost. According to the test results, the 2L size collar under the bed level showed better performance and reduced the final scour depth by 58% in comparison with the control abutment. In another study has been investigated the effect of the Froude number on the scour depth around a circular section of bridge pier with netted unsymmetrical collar (Raeisi and Ghomeshi, 2020). The results showed that the scour depth and the area of scour holes increase, and the collar performance decreases to minimize the scour depth by increasing the level of collar installation on the bridge pier. Additionally, the scour depth was reduced to 72% by installing the netted collar of 15% at bed level and in Froude number of 0.26. Also, the result was similar to the scour depth changes by installing the netted collar of 30 and 40% at the height of 2cm above bed level. In one related research, the flat plate collar was fabricated in the laboratory to reduce the scour depth and tested under different kinds of flow conditions. This collar is designed in equilibrium time conditions and was able to control horseshoe vortices (Valela et al., 2021). It also examined the flow field and shear stress of the bed around the collar by a numerical model. This study showed that the scour depth downstream of the pier decreased

between 69.7 to 75.7%. Finally, another research has been done on cylindrical piers of a bridge and two-piers-in-tandem in clear water conditions considering scouring of horseshoe vortices near the collar (Garg et al., 2021). This study compared single collars around the pier and continuous collars around the two piers against scouring. Moreover, in terms of the two piers test, their protective effect was examined against scouring. Its performance was calculated to be about 67 to 100% for 2.5D and 3D continuous collars around the bases with 2D intervals. According to the results of studies and the use of different types of collars such as netted collars and collars with different geometric shapes in previous research, it was shown that the use of any type of collar has a great effect on reducing the scour depth around the bridge piers and also, different performances can be expected from them by changing their shape and dimensions. However, the collar is a low thickness plate that may not function properly due to flow pressure during floods or on bridges with many and dense piers. Therefore, more research is needed on the use of different types of collars to reduce scouring around bridge piers, which is both more resistant to torrent and also easy to install. Accordingly, this study aimed to investigate the effect of using a flexible collar with permeability around bridge piers. In this regard, according to the defined scenarios, the collar was examined that might be used during the operation of the bridge.

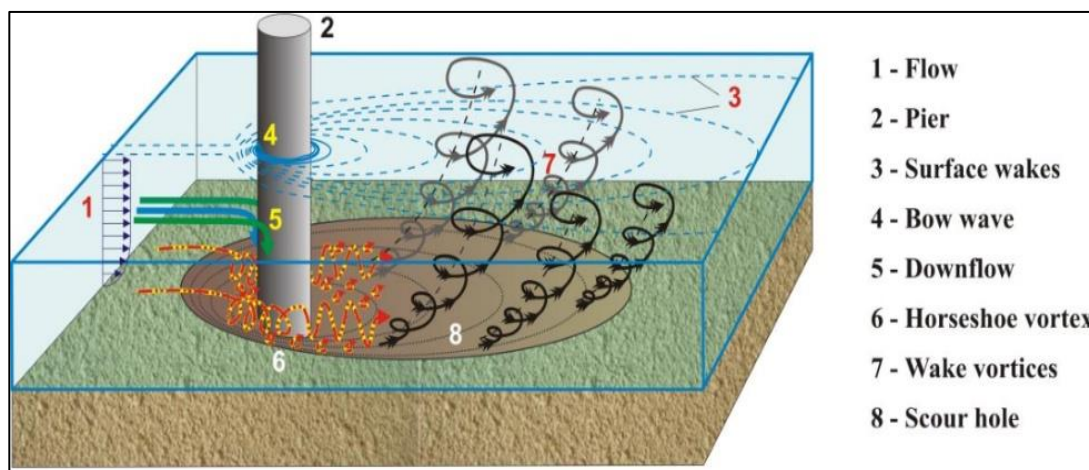

Fig. 1- Flow pattern and local scour hole around a cylindrical bridge pier (Yang et al., 2020)

Materials and Methods

Dimensional Analysis

Numerous parameters such as sediment characteristics, cross-section geometry, bridge pier shape, and flow characteristics affect the scour depth around the bridge piers. This study determined the local scour depth parameters and then dimensioned them by the Buckingham dimensional analysis method. The essential parameters in this research are shown according to Eq. (1).

$$F_1(d_{s_{max}}, d, d_{50}, d_s, y, w, U, U_c, g, \rho, \mu, B, D, T, t) = 0 \quad (1)$$

In this equation, $d_{s_{max}}$ is the maximum scouring depth for pier without protection (control test), d is the pier width, d_{50} is the sediment particle diameter, d_s is the scour depth, y is the flow depth, w is the collar diameter, U is the flow velocity, U_c is the bed inception motion velocity, g is the gravity acceleration, ρ is the fluid specific gravity, μ is the water viscosity, B is the Flume width, D is the chain diameter, T is the equilibrium time, and t is the test time. By applying Buckingham's dimensional analysis method and assuming d , U , and ρ as iterative variables, the equation can be written as the following dimensionless function (2):

$$F_2(Re, Fr_c, \frac{d}{d_{50}}, \frac{d_s}{d}, \frac{d_s}{d_{s_{max}}}, \frac{U}{U_c}, \frac{y}{d}, \frac{w}{d}, \frac{B}{d}, \frac{D}{d}, \frac{t}{T}) = 0 \quad (2)$$

According to the study (Rajaratnam and Ahmed, 1998), since the Reynolds number (Re) in this equation exceeded 3000 for all experiments, the flow is entirely turbulent, and the Reynolds number can be neglected. In addition, $Fr_c = \frac{U_c}{\sqrt{gd_{50}}}$ is the Froude numbers of the particle at the inception motion which was disregarded because all the tests were conducted below the inception motion. It should be noted that the relative velocity parameter (U/U_c) was used to investigate the scour of the piers in similar hydraulic conditions, which was consistently

considered equal to 0.96 in the tests. Considering that the parameters B , y , and w are fixed in all tests conducted, so the effect of these parameters can be neglected in the defined scenarios, and Eq.(3) can be written as the following functions (3):

$$F_3\left(\frac{d_s}{d}, \frac{d_s}{d_{s_{max}}}, \frac{U}{U_c}, \frac{D}{d}, \frac{t}{T}\right) = 0 \quad (3)$$

And

$$\frac{d_s}{d} = F_4\left(\frac{d_s}{d_{s_{max}}}, \frac{D}{d}, \frac{U}{U_c}, \frac{t}{T}\right) \quad (4)$$

In relations 3 and 4, $\left(\frac{d_s}{d}, \frac{d_s}{d_{s_{max}}}\right)$ are relative scour depth, $\left(\frac{D}{d}\right)$ is the relative diameter of the collar, $\left(\frac{U}{U_c}\right)$ is the relative velocity, and $\left(\frac{t}{T}\right)$ is the dimensionless parameter of time.

Laboratory Setup

To investigate the effect of the flexible collar, the tests were conducted in a Gunt research flume located in the Hydraulics and Fluid Laboratory of the KWPA Research and Educational Center. Figure (2) shows the flume's specifications in a schematic sketch. The flume shown in the image is 10 meters long, 31 centimeters wide, and 50 centimeters high. The frame of the flume is metal with a rectangular cross-section and the ability to change the slopes. Its walls are glass, which allows for observing the channel's flow and other phenomena. Moreover, the water supply system was circulating, which allowed the tests to continue for a long time. For this purpose, water was transferred from three interconnected reservoirs installed under the flume, each with a capacity of 1000 liters by a pump with a maximum flow of 51 liters per second and flow control by a bypass valve. An electromagnetic flow-meter was used for measuring the inlet flow with an accuracy of ± 0.1 lit/sec. Water depth was adjusted with a downstream rectangular weir.

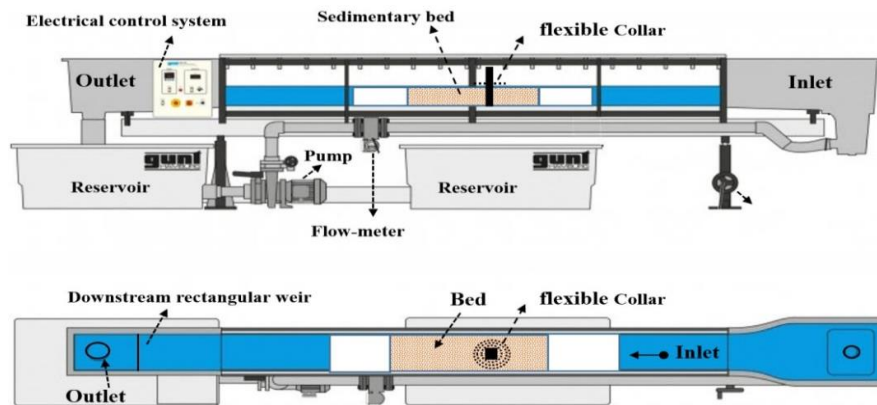

Fig. 2 - Definition sketch of the testing flume

Experimental set-up (Control of laboratory restrictions of scenarios)

A. Model dimensions (Selecting the pier diameter)

Since the first step to reaching the maximum scour depth is to determine the values of allowable parameters affecting the scour depth, the effective parameters are considered by the various criteria proposed by previous researchers. The following scales are selected to achieve the conditions in which the maximum depth of local scouring is formed. For choosing the pier diameter, the side effect of the channel walls on the local scour around the pier must be considered. According to (Chiew and Melville, 1987), the pier diameter should not exceed 10% of the channel width ($\frac{d}{b} \geq 10$) and based on the (Raudkivi and Ettema, 1983) idea, the ratio of channel width to pier diameter should be greater than 6.25. Considering these criteria, the Teflon pier was used with a 3 cm diameter for the basic model. To fix the pier inside the sediments, the basic model was attached to a horizontal PVC plate and placed at a distance of 1-meter at the beginning of the 2-meter sedimentary zone.

B. Regard of Uniformity Criteria and Sediment Size

The sediment particle diameter (d_s) should provide the maximum scour depth around the bridge pier while leaving the equilibrium scouring depth unaffected by sedimentary particles size (Melville (1997). On the other hand, the minimum of $\frac{d}{d_{50}}$ to be 25 (d is the pier diameter or width and (d_{50}) is the mean sedimentary particles size). Moreover, Raudkivi and Ettema (1983) have suggested

the relative of $\frac{d}{d_{50}}$ to be at least between 20 to 25. In this study, this ratio is equal to 31.58, which covers the above criteria. According to the recommendation (Raudkivi and Ettema, 1983), the average size of sediment particles should be more than 0.7 mm to prevent ripple formation. Therefore, the average size of sediment particles d_{50} equal to 0.95 mm was chosen to obtain the maximum scour while avoiding ripples formation creating. Since the non-uniformity of sediments reduces, the final local scour is affecting by the phenomenon of armoring the scour hole, if the sediment's geometric deviation of $\delta_g = \sqrt{\frac{d_{84}}{d_{16}}}$ is less than 1.5 then, the condition of particle uniformity is established, and finally, the effect of sediment non-uniformity is not considered on local scouring (Shafai Bejestan et al., 2010). In this research, natural river sand was selected with a uniform grain size ($\delta_g = 1.36$) and a relative density ($G_s = 2.64$) and also the size of sediment particles equaled to the average diameter of particles $d_{50}=0.95$ mm which corresponds to the above criteria.

C. Selection of Flow Depth and Velocity

Flow depth and velocity affect the final scour depth if they are selected incorrectly. According to (Chiew, 1995), to avoid the effects of flow depth on the scouring rate, it should be three times greater than the pier diameter or width ($y \gg 3d$). Melville and Chiew (1999) argued that the maximum shear stress should be investigated in clear water to determine the flow depth. When the flow velocity is in the range of $0.3U_c < U < U_c$, it indicates the scour is in clear water, and

the live-bed scour occurs when the mean velocity (U) exceeds the critical velocity (U_c). In this research, the experiments were designed around the clear water, and to determine the critical velocity, computational and laboratory observations methods were used (Figure 3). The critical flow velocity is calculated by establishing a constant depth and gradually increasing the flow rate in several repetitions stages. Melville's equations provide a reasonable estimation of the Shields curve to determine the critical shear velocity for the average size of bed

quartz particles in 20 °C water (Melville, 1997).

$$FOR \rightarrow 0.1mm < d_{50} < 1mm$$

$$U_{*c} = 0.0115 + 0.0125d_{50}^{1.4} \tag{5}$$

$$FOR \rightarrow 1mm < d_{50} < 100mm$$

$$U_{*c} = 0.305d_{50}^{0.5} - 0.0065d_{50}^{-1} \tag{6}$$

The logarithmic velocity distribution equation was used for critical velocity:

$$U_c = 5.75 \log(5.53 \frac{y}{d_{50}}) \times U_{*c} \tag{7}$$

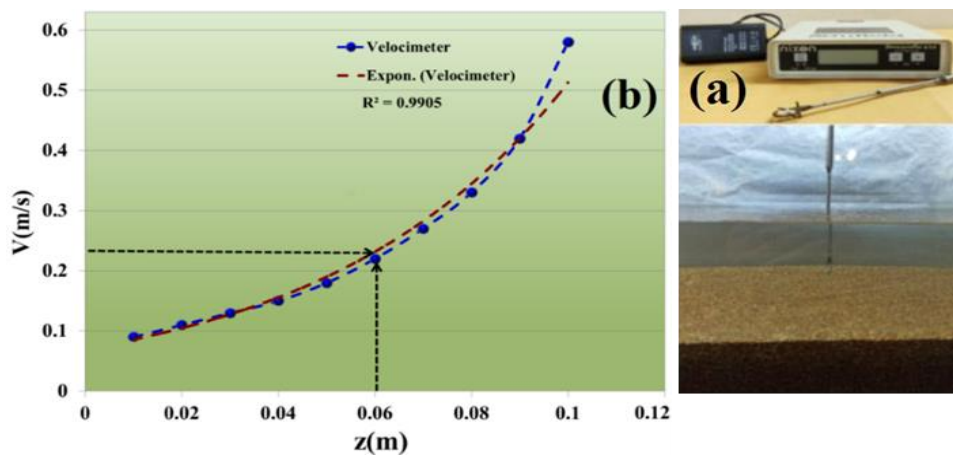

Fig. 3 - (a) Armfield-Streamflo Velocity Meter and (b) Velocitymeter's graph

Table 1- Summary of experimental hydraulics condition

Flume width (Cm)	Square pier width (Cm)	Mean particles size (mm)	Water depth (Cm)	Water discharge (m ³ /h)	Relative velocity	Reynolds	Froude
B	d	d ₅₀	y	Q	U/U _c	Re	Fr
31	3	0.95	10	21<Q<29	0.73<U/U _c <0.96	>20000	0.19<Fr<0.26

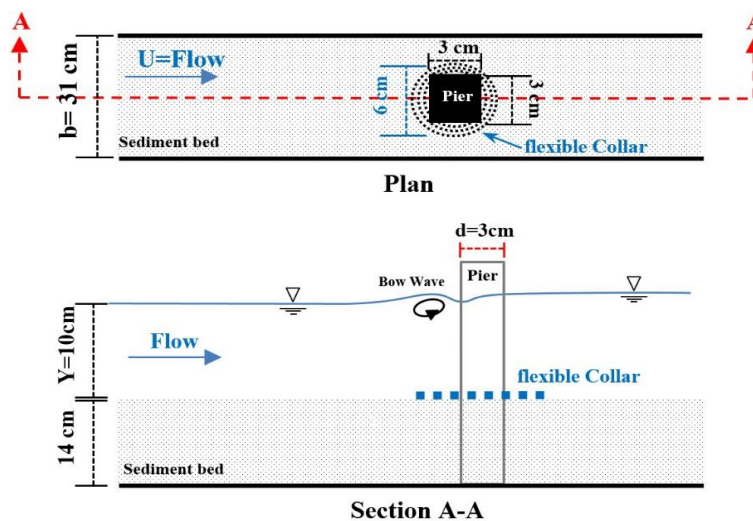

Fig. 4 - Sketch of the testing setup

According to previous equations, the sediment incipient motion velocity was $U_c=0.183$ m/s. However, laboratory observations in different depths and velocities resulted in $U_c=0.22$ m/s. Therefore, in all experiments, this velocity was considered the basis for the velocity of incipient motion. According to these criteria and calculated sedimentary particle incipient motion velocity, the $U/U_c=0.96$ condition was established with a constant 10cm flow depth. Assuming $U/U_c=0.96$, all scenarios can be compared in identical conditions close to the bed sediment incipient motion. Table (1) shows the experiment components according to the scenarios.

D. Time Duration of Experiments

To determine the experiments' equilibrium time, a lengthy investigation was conducted for 12-hours on the control pier test. Figure (5) show that approximately 98% of the scour depth occurs after almost 480 minutes. Therefore, the equilibrium time in all the

experiments was considered to be 8 hours (Melville and Chiew, 1999).

Models Specifications

This study used three different models of flexible and permeable collars (chain) and a square pier with a width of $d=3$ cm and a height of 20 cm made of plexiglass (Figure 4). One of the piers was used as a control test (without protection), and the other three piers were used to twist the flexible collar with chain diameters $D/d = 0.17, 0.33,$ and 0.5 . Figure (6) shows the models specifications. To investigate the quantity effect of the flexible and permeable collar on scouring rate, the percentage of scouring depth reduction according to Eq. (8) was used where d_s and d_{smax} represent the scour depth and the equilibrium scour depth, respectively.

$$R\% = \left(\frac{d_{smax} - d_s}{d_{smax}} \right) \times 100 \tag{8}$$

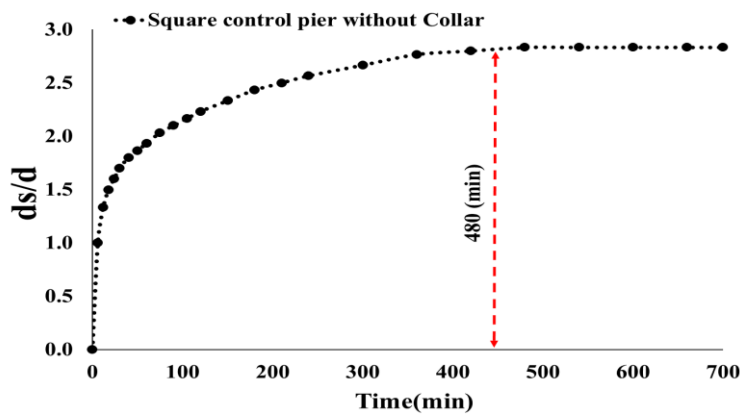

Fig. 5 - Time variations of scour depth

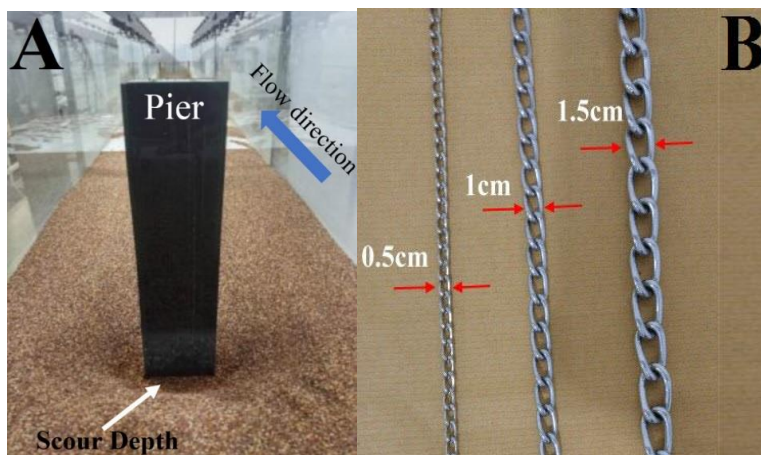

Fig. 6 – (A) pier in test and (B) Chain for flexible collar

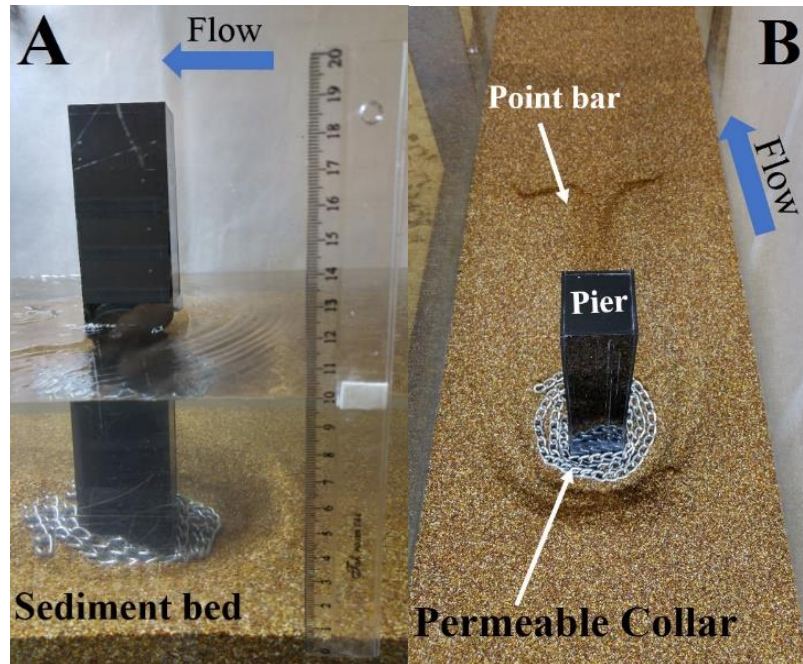

Fig. 7 - Photos of experimental tests

Experiments

To do the experiments, after placing the pier model of the bridge and twisting the collar, the bed sediments were leveled evenly across the channel in the longitudinal directions. Before starting the pump, the downstream weir was adjusted. The water gently was directed from the inlet channel to the model to prevent disturbing the bed sediments and creating ripple at the bed surface. After raising the water level, the pump was started with a low flow, reaching the target level. During the experiments, the maximum scouring depth around the pier at different times was measured by a mechanical depth gauge with millimeter accuracy. At the end of each experiment, the drainage valves installed at the bottom of the channel were opened by cutting the inlet flow to the channel. The water was gently drained so that no change occurred in the topography around the pier. Finally, the bed's topography around the pier was surveyed with a laser meter with millimeter accuracy and a 1×1 cm mesh plate (Figure 7).

A) Un-protected Pier Test (Control tests)

At first, the scour of the square pier of the unprotected bridge was examined as a control test to be a basis for controlling and compared with other cases in reducing the amount of scour depth and bed changes. Also, as mentioned earlier, a control test was conducted for 12 hours on the pier (without collar) to determine the test's duration (equilibrium time), and changes in the scour depth were recorded per unit time during the test.

B) Pier Test with Collar Protection

According to Fig. (7), the chains with different diameters are wrapped around the piers in the form of a collar diameter of 9 cm. Figure (7) shows the formation of scour holes and sediment ridges in the pier model with a CII collar. In the following, the longitudinal profiles of the bed level are drawn for comparison with each other. Also, Table (2) presents the different scenarios of the tests and their conditions for further investigation.

Table 2- Details of experiments

Row	Models	Dimensionless chain diameter	Relative velocity	Dimensionless relative depth	Scour reduction Percentage
Test	Pier's name	$\frac{D}{d}$	$\frac{U}{U_c}$	$\frac{d_s}{d_{s_{max}}}$	$\frac{d_s}{d} \%$
1	CI	0.17	0.73	0.06	94
2	CI	0.33	0.85	0.12	88
3	CI	0.50	0.96	0.41	59
4	CII	0.17	0.73	0.07	93
5	CII	0.33	0.85	0.14	86
6	CII	0.50	0.96	0.35	65
7	CIII	0.17	0.73	0.08	92
8	CIII	0.33	0.85	0.15	85
9	CIII	0.50	0.96	0.29	71
10	Unprotecting	-	0.73	0.35	-
11	Unprotecting	-	0.85	0.59	-
12	Unprotecting	-	0.96	1.00	-

Results and Discussion

Most of the bridge piers need protection against scouring after construction, for which researchers have suggested different solutions. The collar method was investigated in this study, one of the direct protection and bed stabilization methods. Also, a flexible chain collar with different diameters was studied. For this purpose, to model the flexible and permeable collar, we rotate the chain around the base of the bridge and place it according to Fig. (7). Figure (8) shows the longitudinal profile of scouring for each collar next to the unprotected control pier. This figure is drawn at $U/U_c = 0.96$, and the collar diameter is the same for all experiments. In addition, the profiles illustrated in the figure are drawn for the three modes of protection scenarios CI, CII, and CIII, against un-protected pier tests. According to the results, profile CIII has fewer scouring holes than the other two profiles. The control tests showed that water flow's contact

with the pier immediately created vortexes around the square pier due to downflow that the scour process starts at a high-speed rate. The horseshoe vortexes start around the pier after increasing the hole depth. The sediments raised from the scour hole were transferred downstream, accumulated on both sides behind the pier in a relatively symmetrical mode, and formed a sedimentary ridge. Sometime after the start of the test, the sediments raised from the scour hole have reached a level that the pier's effect on the bed surface reduced, and the impact of vortexes behind the pier became negligible. In this condition, the secondary flow affected the sediments transferred from the scour hole toward downstream. Eventually, after 8 hours, the scouring rate decreased significantly. It was also observed that the scour depth at the front of the pier had a maximum value, and it decreased by moving away from the pier.

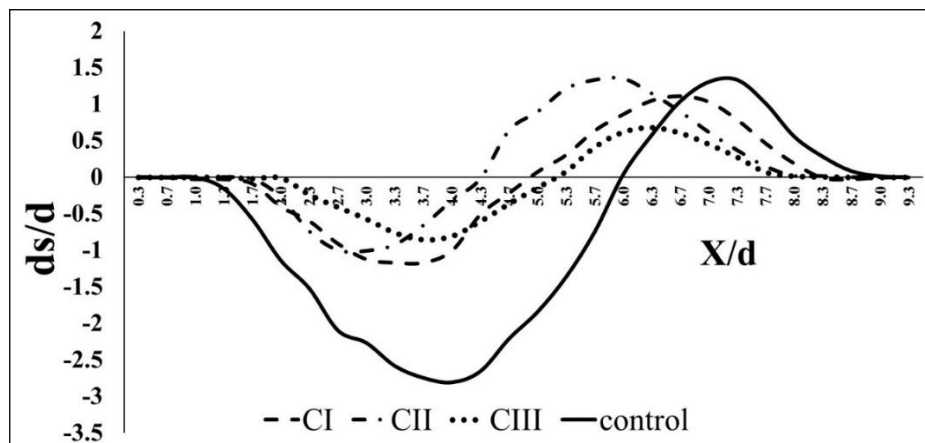

Fig. 8 - Longitudinal bed profiles

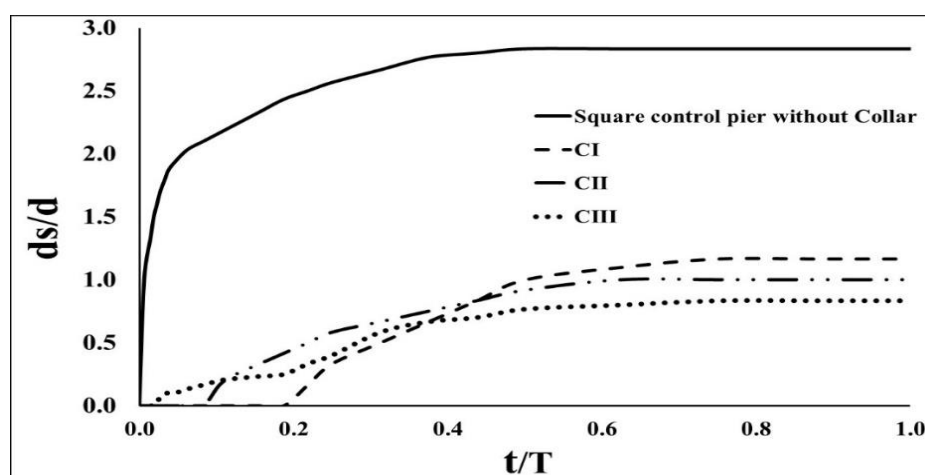

Fig. 9 - Equilibrium time variations of scour depth

Figure (9) shows the equilibrium tests for different scenarios at $U/U_c = 0.96$. According to the figure, at first, the scouring hole was not observed for approximately 200 seconds for the CI scenario, after which the scouring hole began to develop. Also, for the CIII scenario, the scour hole development started as soon as the test began. However, it was observed that the equilibrium scouring depth of CIII with a larger relative diameter is less than CI with a smaller relative diameter and CII with a medium relative diameter. After reviewing the test results, it was found that the reason for this event is that there is no interaction between the collar in the CI scenario and the flow at the beginning of the test. However, over time, interference between the flow lines and chains occurs in smaller holes, and scouring begins and develops around them. However, in a chain with larger holes, the flow colliding with the holes occurs from the beginning, and scouring begins. Figure (10) shows the percentage of scour depth reduction and the sensitivity of

each protection to changes in flow conditions (U/U_c). According to the figure, in the dimensionless ratio of flow velocity, below the inception motion, the dimensionless scouring ratio for all three types of protection are very close, and their effects are similar. For example, the protection value is more than 90% for all three types of collars at ($U/U_c=0.73$). However, at ($U/U_c=0.96$), the percentage of scouring reduction is 71% for collars with a larger relative diameter (CIII) and 59% for collars with a smaller relative diameter (CI), that the difference between the two scenarios is equal to 12%. It indicates that at ($U/U_c=0.96$), the flexible collar with a larger relative diameter (CIII) has a better ability in scouring control.

Figure (11) shows the dimensionless ratio of scour depth (ds/d) in different flow conditions versus the dimensionless ratio of flow velocities (U/U_c). According to the figure, in relative speeds of 0.73% and 0.85%, the dimensionless scouring ratio is the same for

all three types of collars, and the scour depth is almost the same for them. However, at a relative speed of 96%, the percentage of chain scouring depth in the CI scenario increased.

compared to CII and CIII scenarios Table (3) compares the results of this study with other researchers in similar circumstances.

Considering that no previous study has been conducted on flexible and permeable collars, in this Table, the results of the netted collars of previous researchers have been compared with the results of the current study. Based on Table (3), the collar in the CIII scenario for scouring control shows better results than other studies.

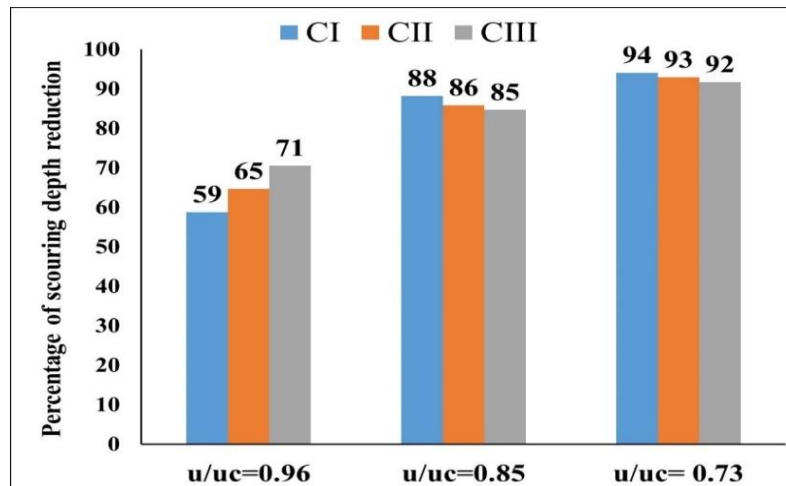

Fig. 10 - Relative scouring depth reduction percentage versus flow relative velocity

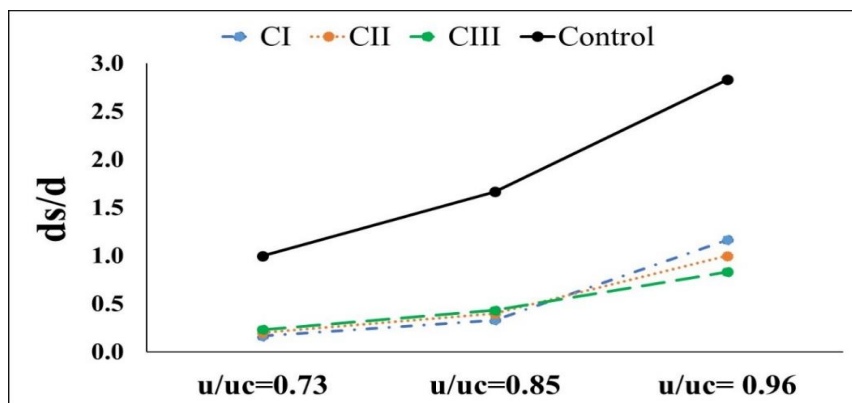

Fig.11 - Dimensionless scouring depth for all scenarios against relative velocity

Table 3- Comparison of the results of the study with other researchers in clear water conditions

Percentage of scour depth reduction (%)	Type of collar	Researcher name
100	Simple bed collar	Jalili and Ghomeshi (2016)
85	Netted collar of 30% in oblong-shape	Taheri and ghomeshi (2018)
37	Unsymmetrical netted collar of 30%	Raeisi and Ghomeshi (2020)
84	Square netted collar of 30%	Bahrami and Ghomeshi (2018)
58	Circular netted collar of 30%	Hemmati et al. (2017)
59	Flexible and Permeable collar (CI Scenario)	Current study
65	Flexible and Permeable collar (CII Scenario)	
71	Flexible and Permeable collar (CIII Scenario)	

Conclusion

In this study, the direct bed protection method with a flexible and permeable collar has been used to control and reduce the scour depth around the bridge piers. Its protection was examined by twisting the chain around the pier and forming a collar-shape plate. By applying these protections and their effect on different relative velocities (U/U_c), the impact of flow was investigated, and the results are as follows:

1. Combining the bridge base and the flexible collar allows the necessary protection to be provided in the conditions of operation when the base is disposed to scouring. It should be noted that other protections should be conducted during construction or in dry seasons.
2. Changing the chain's diameter changes the scour depth ratio, and increasing the diameter of the chain from CI to CIII decreases the final scour depth.
3. Based on the results of the equilibrium test for each scenario, there is no interaction between the chain and the flow in the chain collar with a smaller relative diameter at the beginning of the test. However, over time, interference between the flow lines and

chains occurs in smaller holes, and scouring begins and develops around them. Nevertheless, in a chain with larger holes, the flow colliding with the holes occurs from the beginning, and scouring begins.

4. In relative speeds of 0.73% and 0.85%, the dimensionless scouring ratio is the same for all three types of collars, and the scour depth is almost the same for them. However, at a relative speed of 96%, the percentage of chain scouring depth in the CI scenario increased compared to CII and CIII scenarios.
5. In the best conditions, the collar structure in the CIII scenario at ($U/U_c=0.96$), the dimensionless ratio of scouring reduction ($\frac{d_s}{d_{smax}}$) is equal to 71%.
6. According to the results in Table (3), the collar in the CIII scenario, with a 71% reduction in the scour depth near the inception motion, has relatively similar results in comparison with rigid collars that were studied in other researches by other researchers.

Acknowledgment

The authors would like to thank the KWPA laboratory for their supports.

References

- 1- Adib, A., Shiri, V. and Shafai Bejestan, M. (2019). On the Local Scour Around Group Piers in Series by Experimental Tests. *Journal of Rehabilitation in Civil Engineering* 7, 21-34.
- 2- Akhlaghi, E., Babarsad, M.S., Derikvand, E. and Abedini, M. (2020). Assessment the Effects of Different Parameters to Rate Scour around Single Piers and Pile Groups: A Review. *Archives of Computational Methods in Engineering* 27, 183-197.
- 3- Alem, Z., Ghomeshi, M. and Mohammadi, S. (2013). The application of collar on the scour reduction at bridge rectangular abutment in composite channel. *Irrigation and Water Engineering* 3, 29-41.
- 4- Bahrami, N. and Ghomeshi, M. (2018). Effect of Netted Collar on Maximum Local Scouring Depth of Cubic Bridge Pile Groups. *Amirkabir Journal of Civil Engineering* 50, 655-664.
- 5- Chiew, Y.-M. (1995). Mechanics of riprap failure at bridge piers. *Journal of hydraulic engineering* 121, 635-643.
- 6- Chiew, Y.-M. and Melville, B.W. (1987). Local scour around bridge piers. *Journal of hydraulic research* 25, 15-26.
- 7- Garg, V., Setia, B., Singh, V. and Kumar, A. (2021). Scour protection around bridge pier and two-piers-in-tandem arrangement. *ISH Journal of Hydraulic Engineering*, 1-13.
- 8- Gohari, S. and Rezaei, M. (2020). Investigating the effect of oblique bed sill on bridge pier scouring with circular cross-section. *Journal Management System* 12, 100-114. (In Persian).

- 9- Hemmati, M., Gholizadeh, N. and Dolatkah, S. (2017). Experimental Investigation of the Effect of Diameter and Placement Level of Lattice Collars on Scour Reduction around Bridge Pier. *Plant protection (scientific journal of agriculture)* 39, 111-122. (In Persian).
- 10- Jalili, A. and Ghomeshi, M. (2016). Influence of Netted Collar on Scour depth around of Cubic Bridge Pier. *Irrigation Sciences and Engineering* 39, 15-25. (In Persian).
- 11- Karimaei Tabarestani, M. (2020). Study on time development of horse-shoe vortex diameter and shear stress at bridge pier.
- 12- Karimi, N., Heidarnejad, M. and Masjedi, A. (2017). Scour depth at inclined bridge piers along a straight path: A laboratory study. *Engineering science and technology, an international journal* 20, 1302-1307.
- 13- Khozaymehnezhad, H. and Ghomeshi, M. (2016). Experimental Investigation of Collar Performance with Rough Surface on Local Scour Reduction around Bridge Abutment with Rectangular Section. *Water and Soil Science* 26, 213-223.
- 14- Melville, B.W. (1997). Pier and abutment scour: integrated approach. *Journal of hydraulic Engineering* 123, 125-136.
- 15- Melville, B.W. and Chiew, Y.-M. (1999). Time scale for local scour at bridge piers. *Journal of Hydraulic Engineering* 125, 59-65.
- 16- Raeisi, N. and Ghomeshi, M. (2020). Laboratory investigation of flow pattern and scour around bridge with netted unsymmetrical collar. *Journal of Hydraulics* 15, 113-128. (In Persian).
- 17- Rajaratnam, N. and Ahmed, F. (1998). Flow around bridge piers. *Journal of Hydraulic Engineering* 124, 288-300.
- 18- Raudkivi, A.J. and Ettema, R. (1983). Clear-water scour at cylindrical piers. *Journal of hydraulic engineering* 109, 338-350.
- 19- Safaei, A., Choramin, M., Khajavi, S., Parmoon, A.A. and Arezoo, A.A. (2015). Analyzing the affective parameters on the amount of bridge scour in the vicinity of the rough collar in laboratory model. *WALIA journal*, 17-21.
- 20- Shafai Bajestan, M.S., Hassanzadeh, H. and Paydar, G.R. (2018). Performance evaluation of correction coefficients to optimize sediment rating curves on the basis of the Karkheh dam reservoir hydrography, west Iran. *Arabian Journal of Geosciences* 11, 595. (In Persian).
- 21- Shafai Bejestan, M., Masjedi, A. and Kazemi, H. (2010). Effects of bridge pier position in a 180 degree flume bend on scour hole depth. *JApSc* 10, 670-675.
- 22- Shahsavari, H., Moradi, S. and Khodashenas, S. (2020). Influence of Semicircular Collar Diameter and Its Alignment on Scour Depth and Flow Pattern around Bridge Abutment. *Iranian Journal of Soil and Water Research* 51, 77-91. (In Persian).
- 23- Solimani Babarsad, M., Hojatkah, A., Safaei, A. and Aghamajidi, R. (2021). Laboratory investigation of deflector structure effect on bridge pier scouring. *Irrigation Sciences and Engineering* 43, 91-104. (In Persian).
- 24- Solimani babarsad, M. and Safaei, A. (2021). Experimental Study of Scour Around Pier with Inclined Head. *Water Resources Engineering* 14, 53-72. (In Persian).
- 25- Solimani Babarsad, M., Safaei, A. and Aghamajidi, R. (2021). Laboratory Study of Cable and Sill Protection on Scouring Pattern Around the Bridge Pier. *Iranian Journal of Soil and Water Research* 52, 523-538. (In Persian).
- 26- Taheri, z. and ghomeshi, m. (2018). Experimental study of the effect of netted collar position on scour depth around of oblong-shape bridge pier.

- 27-Valela, C.,Rennie, C.D. and Nistor, I. (2021). Improved bridge pier collar for reducing scour. *International Journal of Sediment Research*.
- 28-Wang, L.,Melville, B.W.,Shamseldin, A.Y. and Nie, R. (2020). Impacts of Bridge Piers on Scour at Downstream River Training Structures: Submerged Weir as an Example. *Water Resources Research* 56, 46-51.
- 29-Yang, Y.,Melville, B.W.,Macky, G.H. and Shamseldin, A.Y. (2020). Experimental study on local scour at complex bridge pier under combined waves and current. *Coastal Engineering* 160, 103730.



© 2021 Shahid Chamran University of Ahvaz, Ahvaz, Iran. This article is an open access article distributed under the terms and conditions of the Creative Commons Attribution 4.0 International (CC BY 4.0 license) (<http://creativecommons.org/licenses/by/4.0/>).